

Network Access Point

05



The 480 series boxes provide a protected access point between distribution cable and drop cable. The structure can support a variety of different fiber outputs, making it an ideal connection point for simplifying network installation and maintenance. The 480 series boxes are suitable for any harsh environment, even if space is limited.

FitDP-480 Series Products

Features

- Removable cover, easy for installation
- Adopting trays with a unique anti-dropping design
- Neat fiber routing management
- Applying UV-resistant material, having good weather adaptability
- Supporting outdoor pipe (SNR), direct-buried ground cable, aerial cable
- Adapter panel design makes the construction clearer and neater
- Independent paper clamp design, suitable for storing construction files
- Protection grade: IP55.

Innovation

- Tool-less sealing

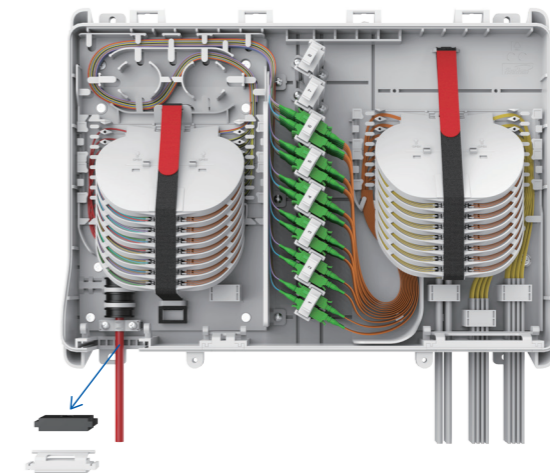

- Removable adapter module

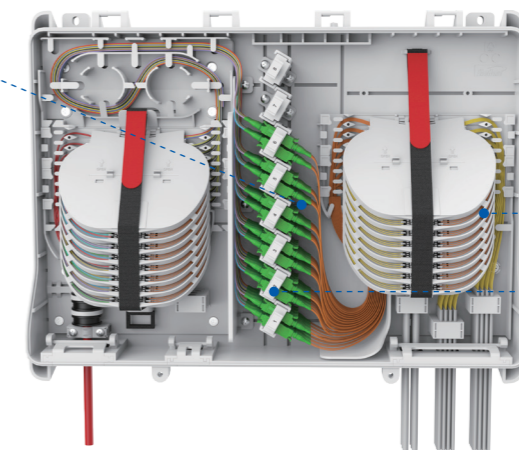
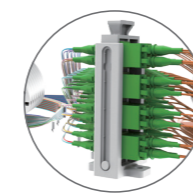

NE4 Cassete

Parking position
NE4-Pigtails

· Modular design (sealed & fixed)

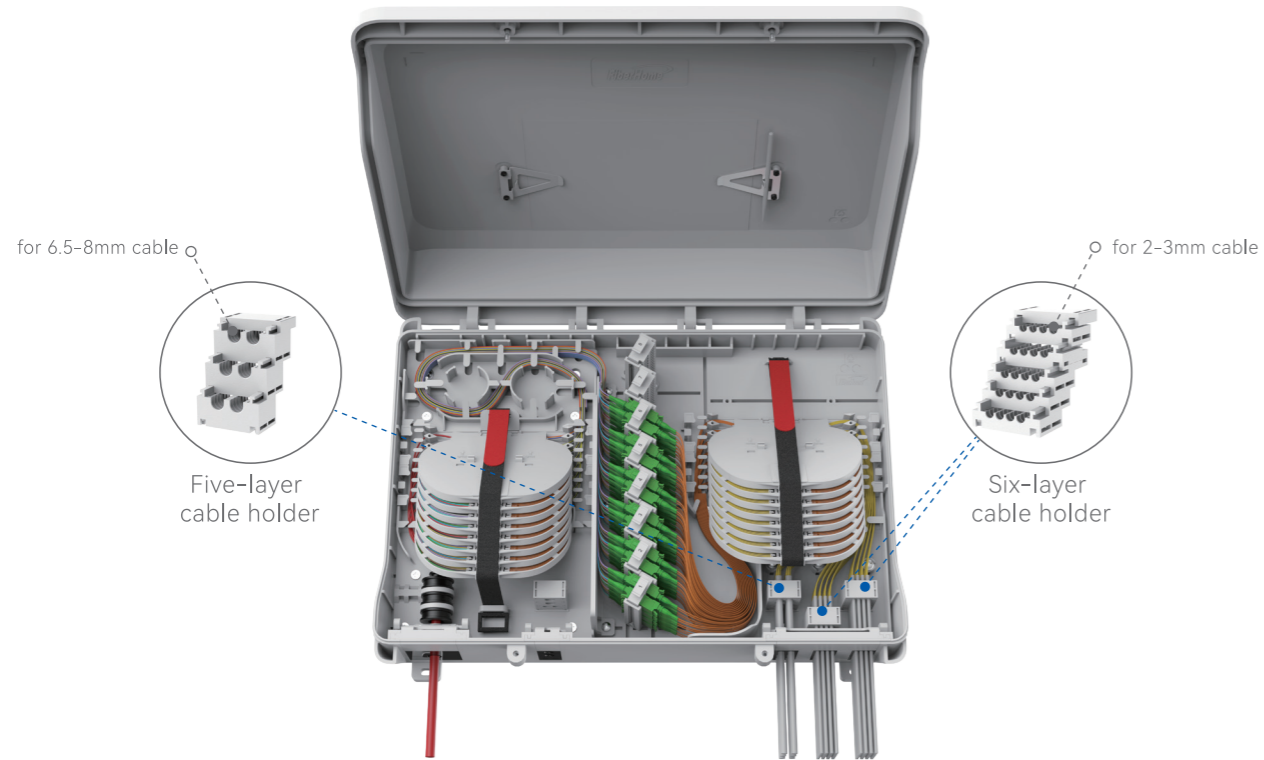

· Detachable and self-limiting design

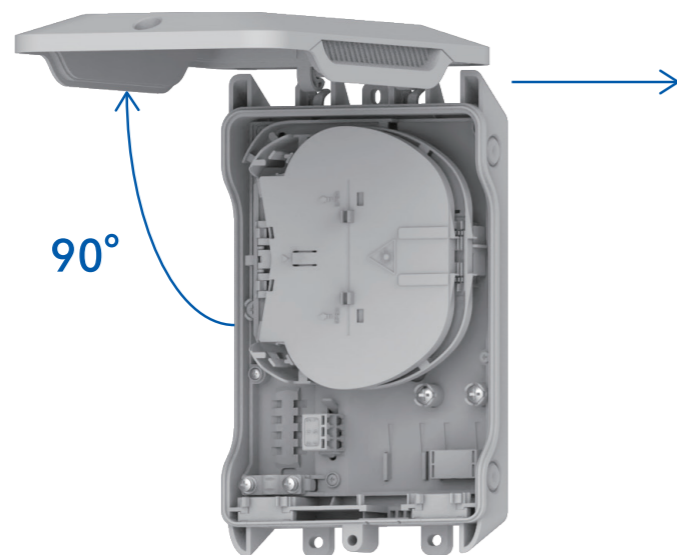

FitDP-480A

Item	Dimension (mm)	Material	Splice capacity
Specification	120×100×25 (±2)	PC+ABS&PC	4F(max)

FitDP-480B

Item	Dimension (mm)	Material	Splice capacity	DLC adaptor capacity
Specification	260×155×48 (±2)	PC/PC+ABS	24F(max)	3 pcs (max)

FitDP-480C

Item	Dimension (mm)	Material	Splice capacity	DLC adaptor capacity
Specification	280×200×65 (±2)	PC/PC+ABS	48F(max)	7 pcs (max)

FitDP-480D

Item	Dimension (mm)	Material	Splice capacity	DLC adaptor capacity
Specification	450×350×110 (±2)	PC/PC+ABS	NE3:96F(max) NE4:144F (max)	64 pcs (max)

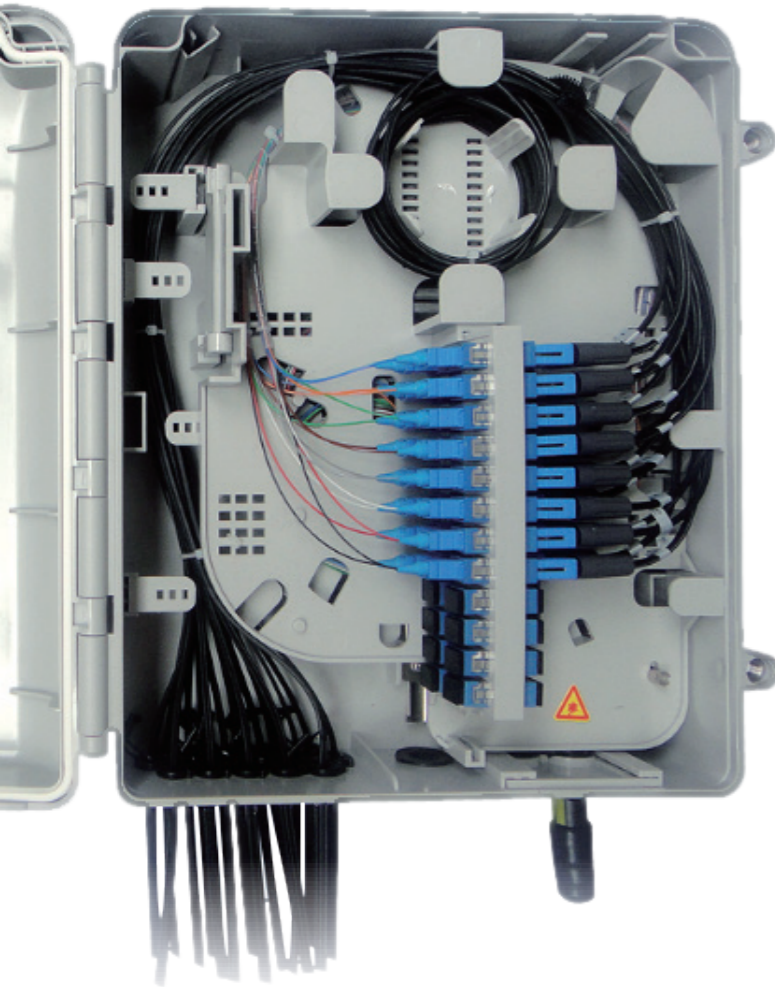

FitDP-410D

Type	FitDP-410D	FitDP-410D-3
Size (HxWxD, mm)	310×250×105	310×250×105
Splice capacity (F)	48	48
Adaptor capacity	24	24
Applicable environment	Indoor	Outdoor

FitDP-410B

Type	FitDP-410D	FitDP-410D-3
Size (HxWxD, mm)	310×250×105	310×250×105
Splice capacity (F)	48	48
Adaptor capacity	24	24
Applicable environment	Indoor	Outdoor

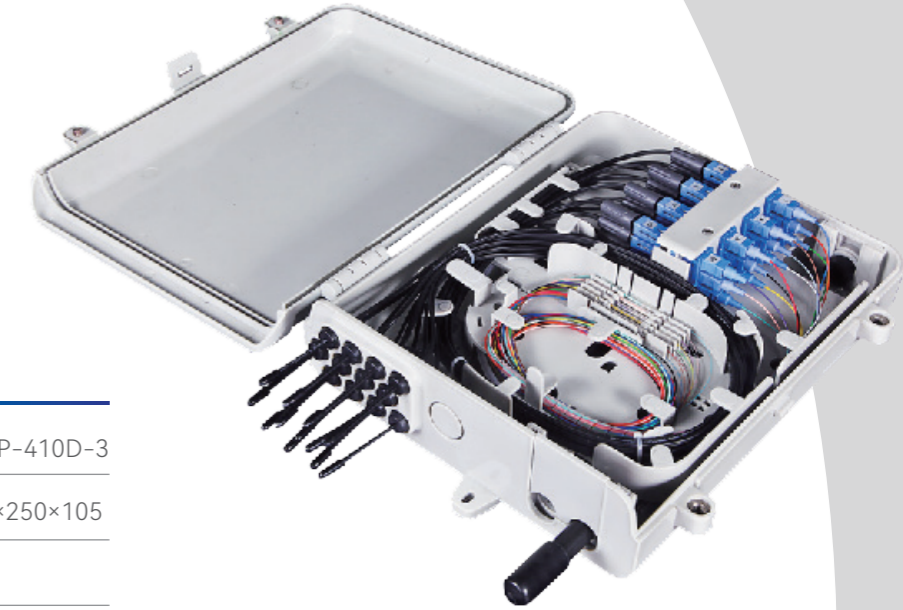

Overview

- Indoor/Outdoor application with good UV resistant
- Wall or pole mounted
- Numerous applications such as mid-span, branch and direct splice
- Pre-installed 2psc 1:8 or 1psc 1:16 micro type
- Protection grade: IP55

Features

- Clear function interface
- The installation is convenient, which can meet the requirements of holding pole and wall hanging

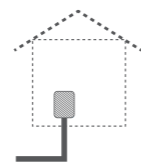

Indoor NAP

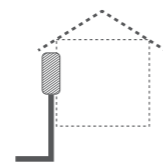

On wall NAP



On pole NAP

FitDP-410E

Type	FitDP-410E	FitDP-410E-2
Size (HxWxD, mm)	400×310×123	400×310×123
Splice capacity (F)	48	48
Adaptor capacity	48	48
Applicable environment	Indoor	Outdoor



FitDP-420E Series

Overview

- In-line, Wall-mounted, pole-mounted installation
- Outdoor application with good UV resistant
- Double side drop cable outlet. Drop cable can lead in at both sides, easy to deploy
- Cassette splitter for easy expansion
- 3 layer structure and easy to maintain
- High strength material with good weather adaptability
- Separate area for distribution cable and drop cable, easy for expansion and service provisioning
- Protection grade: IP55



3 layer structure and easy to maintain



Outdoor application and good UV resistant

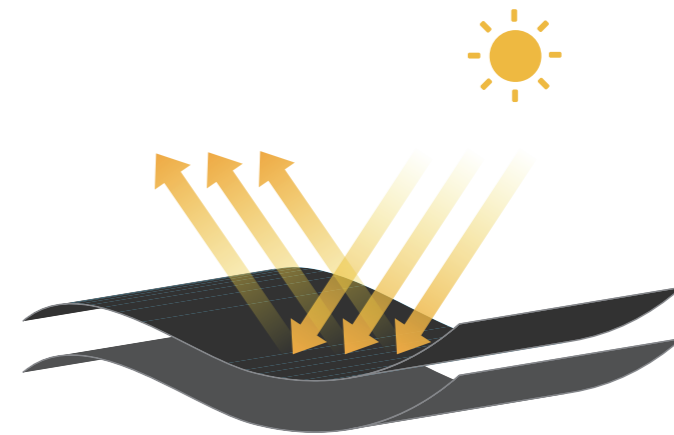

FitDP-420E series

Type	Size (HxWxD, mm)	Splice capacity (F)	Adaptor capacity	Splitter capacity	Applicable environment
FitDP-420E-A1	175x285x110	24	8	1pcs 1:8	Outdoor
FitDP-420E-A2	175x285x110	24	16	2pcs 1:8	Outdoor
FitDP-420E-A3	175x285x110	24	16	1pcs 1:8	Outdoor



FitDP-420A series



FitDP-420F series

FitDP-420A series

Type	Size (HxWxD, mm)	Splice capacity (F)	Adaptor capacity	Splitter capacity	Applicable environment
FitDP-420A-A1	248.5×305×120	20	18	2pcs 1:8	Outdoor
FitDP-420A-A2	248.5×305×120	20	18	1pcs 1:16	Outdoor
FitDP-420A-A3	248.5×305×120	20	18	2pcs 1:8	Outdoor

FitDP-420F series

Type	Size (HxWxD, mm)	Splice capacity (F)	Adaptor capacity	Splitter capacity	Applicable environment
FitDP-420F-A1	175x285x92	24	\	\	Outdoor
FitDP-420F-A2	175x285x92	48	\	\	Outdoor
FitDP-420F-A3	175x285x92	72	\	\	Outdoor
FitDP-420F-A4	175x285x92	96	\	\	Outdoor



FitDP-430C



FitDP-440A

FitDP-430C

Type	Size (HxWxD, mm)	Splice capacity (F)	Adaptor capacity	Applicable environment
FitDP-430C-SA-xx	242x129x337	40	2pcs 1:8	Outdoor

FitDP-440A

Type	Size (HxWxD, mm)	Splice capacity (F)	Adaptor capacity
FitDP-440A	210×270×70	24	8